



## *Installation Instructions*

# ControlLogix ControlNet Interface Module

Catalog Numbers 1756-CNB, 1756-CNBR, Series E

### Contents

For	See Page
Important User Information	2
European Hazardous Location Approval	3
North American Hazardous Location Approval	4
Environment and Enclosure	5
Prevent Electrostatic Discharge	6
About the 1756-CNB and 1756-CNBR Series E Modules	6
Understand Standalone and Redundant Control	7
Before You Begin	8
Install or Remove the Module Under Power	14
Install the Module	15
Remove the Module	16
Connect the Module to the Network	17
Troubleshoot the Module	23
Interpret the Module Status Indicator and Display	24
ControlNet Network Channel Status Indicators	28
Specifications	30
Rockwell Automation Support	BackCover

### About This Publication

Use this document as a guide to install the ControlLogix ControlNet Bridge module.

### Important User Information

Solid state equipment has operational characteristics differing from those of electromechanical equipment. Safety Guidelines for the Application, Installation and Maintenance of Solid State Controls (Publication SGI-1.1 available from your local Rockwell Automation sales office or online at <http://literature.rockwellautomation.com/>) describes some important differences between solid state equipment and hard-wired electromechanical devices. Because of this difference, and also because of the wide variety of uses for solid state equipment, all persons responsible for applying this equipment must satisfy themselves that each intended application of this equipment is acceptable.





In no event will Rockwell Automation, Inc. be responsible or liable for indirect or consequential damages resulting from the use or application of this equipment.

The examples and diagrams in this manual are included solely for illustrative purposes. Because of the many variables and requirements associated with any particular installation, Rockwell Automation, Inc. cannot assume responsibility or liability for actual use based on the examples and diagrams.

No patent liability is assumed by Rockwell Automation, Inc. with respect to use of information, circuits, equipment, or software described in this manual.

Reproduction of the contents of this manual, in whole or in part, without written permission of Rockwell Automation, Inc., is prohibited.

Throughout this manual, when necessary, we use notes to make you aware of safety considerations.

<b>WARNING</b> 	Identifies information about practices or circumstances that can cause an explosion in a hazardous environment, which may lead to personal injury or death, property damage, or economic loss.
<b>IMPORTANT</b>	Identifies information that is critical for successful application and understanding of the product.
<b>ATTENTION</b> 	Identifies information about practices or circumstances that can lead to personal injury or death, property damage, or economic loss. Attentions help you identify a hazard, avoid a hazard, and recognize the consequences.
<b>SHOCK HAZARD</b> 	Labels may be located on or inside the equipment (for example, drive or motor) to alert people that dangerous voltage may be present.
<b>BURN HAZARD</b> 	Labels may be located on or inside the equipment (for example, drive or motor) to alert people that surfaces may be dangerous temperatures.

## European Hazardous Location Approval

### European Zone 2 Certification

(The following applies when the product bears the EEx Marking.)

This equipment is intended for use in potentially explosive atmospheres as defined by European Union Directive 94/9/EC.

The LCIE (Laboratoire Central des Industries Electriques) certifies that this equipment has been found to comply with the Essential Health and Safety Requirements relating to the design and construction of Category 3 equipment intended for use in potentially explosive atmospheres, given in Annex II to this Directive. The examination and test results are recorded in confidential report No. 28 682 010.

Compliance with the Essential Health and Safety Requirements has been assured by compliance with EN 50021.

---

**IMPORTANT**

This equipment is not resistant to sunlight or other sources of UV radiation.

The secondary of a current transformer shall not be open-circuited when applied in Class I, Zone 2 environments.

Equipment of lesser Enclosure Type Rating must be installed in an enclosure providing at least IP54 protection when applied in Class I, Zone 2 environments.



This equipment shall be used within its specified ratings defined by Allen-Bradley.

Provision shall be made to prevent the rated voltage from being exceeded by transient disturbances of more than 40% when applied in Class I, Zone 2 environments.

---

## North American Hazardous Location Approval

<p>The following information applies when operating this equipment in hazardous locations:</p>	<p>Informations sur l'utilisation de cet équipement en environnements dangereux:</p>
<p>Products marked "CL I, DIV 2, GP A, B, C, D" are suitable for use in Class I Division 2 Groups A, B, C, D, Hazardous Locations and nonhazardous locations only. Each product is supplied with markings on the rating nameplate indicating the hazardous location temperature code. When combining products within a system, the most adverse temperature code (lowest "T" number) may be used to help determine the overall temperature code of the system. Combinations of equipment in your system are subject to investigation by the local Authority Having Jurisdiction at the time of installation.</p>	<p>Les produits marqués "CL I, DIV 2, GP A, B, C, D" ne conviennent qu'à une utilisation en environnements de Classe I Division 2 Groupes A, B, C, D dangereux et non dangereux. Chaque produit est livré avec des marquages sur sa plaque d'identification qui indiquent le code de température pour les environnements dangereux. Lorsque plusieurs produits sont combinés dans un système, le code de température le plus défavorable (code de température le plus faible) peut être utilisé pour déterminer le code de température global du système. Les combinaisons d'équipements dans le système sont sujettes à inspection par les autorités locales qualifiées au moment de l'installation.</p>

<p><b>WARNING</b></p> 	<p><b>EXPLOSION HAZARD</b></p> <p>Do not disconnect equipment unless power has been removed or the area is known to be nonhazardous.</p> <p>Do not disconnect connections to this equipment unless power has been removed or the area is known to be nonhazardous. Secure any external connections that mate to this equipment by using screws, sliding latches, threaded connectors, or other means provided with this product.</p> <p>Substitution of components may impair suitability for Class I, Division 2.</p> <p>If this product contains batteries, they must only be changed in an area known to be nonhazardous.</p>	<p><b>AVERTISSEMENT</b></p> 	<p><b>RISQUE D'EXPLOSION</b></p> <p>Couper le courant ou s'assurer que l'environnement est classé non dangereux avant de débrancher l'équipement.</p> <p>Couper le courant ou s'assurer que l'environnement est classé non dangereux avant de débrancher les connecteurs. Fixer tous les connecteurs externes reliés à cet équipement à l'aide de vis, loquets coulissants, connecteurs filetés ou autres moyens fournis avec ce produit.</p> <p>La substitution de composants peut rendre cet équipement inadapté à une utilisation en environnement de Classe I, Division 2.</p> <p>S'assurer que l'environnement est classé non dangereux avant de changer les piles.</p>
---	--	---	--

---

## Environment and Enclosure

---

**ATTENTION**

This equipment is intended for use in a Pollution Degree 2 industrial environment, in overvoltage Category II applications (as defined in IEC publication 60664-1), at altitudes up to 2000 meters without derating.

This equipment is considered Group 1, Class A industrial equipment according to IEC/CISPR Publication 11. Without appropriate precautions, there may be potential difficulties ensuring electromagnetic compatibility in other environments due to conducted as well as radiated disturbance.

This equipment is supplied as open-type equipment. It must be mounted within an enclosure that is suitably designed for those specific environmental conditions that will be present and appropriately designed to prevent personal injury resulting from accessibility to live parts. The interior of the enclosure must be accessible only by the use of a tool. Subsequent sections of this publication may contain additional information regarding specific enclosure type ratings that are required to comply with certain product safety certifications.

NOTE: See NEMA Standards publication 250 and IEC publication 60529, as applicable, for explanations of the degrees of protection provided by different types of enclosure. Also, see the appropriate sections in this publication, as well as Industrial Automation Wiring and Grounding Guidelines, Allen-Bradley publication 1770-4.1, for additional installation requirements pertaining to this equipment.

---

## Prevent Electrostatic Discharge

---

**ATTENTION**



This equipment is sensitive to electrostatic discharge, which can cause internal damage and affect normal operation. Follow these guidelines when you handle this equipment:

- Touch a grounded object to discharge potential static.
  - Wear an approved grounding wriststrap.
  - Do not touch connectors or pins on component boards.
  - Do not touch circuit components inside the equipment.
  - If available, use a static-safe workstation.
  - When not in use, store the equipment in appropriate static-safe packaging.
- 

For additional information, refer to Industrial Automation Wiring and Grounding Guidelines, publication 1770-4.1.

## About the 1756-CNB and 1756-CNBR Series E Modules

The 1756-CNB and 1756-CNBR Series E modules work for all nonredundant ControlLogix applications.

---

**IMPORTANT**

Only the 1756-CNB and 1756-CNBR, Series D modules are supported in ControlLogix Redundancy releases 8, 11, 13, and 15. After a firmware upgrade to version 11.xx, Series E will be supported in ControlLogix Redundancy release 15 or later.

You cannot upgrade a Series D module to a Series E module.

---

## Understand Standalone and Redundant Control

You can use the 1756-CNB and 1756-CNBR Series E modules as standalone or in firmware version 11.xx as redundant control. For standalone control, only one set of modules is required. For redundant control, two ControlLogix chassis are populated with identical pairs of modules called partners. The chassis that performs active control is called the primary chassis and the modules in the chassis are called primary modules. The other chassis is called the secondary chassis and the modules in the chassis are called secondary modules. These installation instructions discuss both standalone and redundant control; read them carefully to distinguish the procedures and requirements for each type of control.

**IMPORTANT**

If you use redundant control, you must select the same ControlNet network address for each set of partner modules. You must also place the partner modules in the same corresponding slots in their respective redundant control chassis pair.

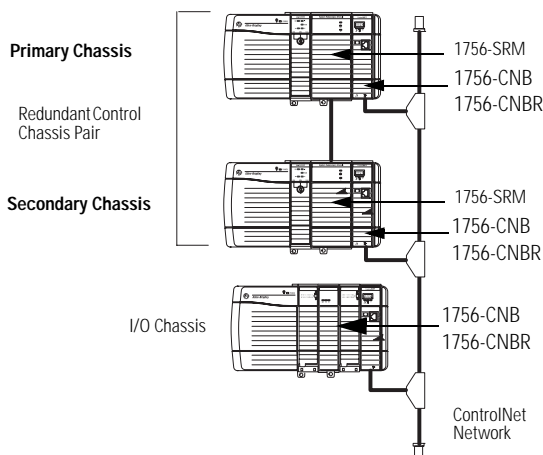

### Before You Begin

Before you install the module you need to make sure you:

- Know how to handle the module.

Refer to the section Prevent Electrostatic Discharge.

- Have all of the necessary components:

1756-CNB or 1756-CNBR

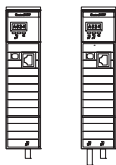

1756-A4, 1756-A7, 1756-A10,  
1756-A13, or 1756-A17

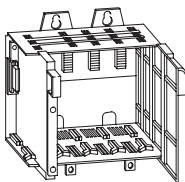

1756-PA72/75 or 1756-PB72/75  
Power Supply



1786-TPR, 1786-TPS  
1786-TPYR, or 1786-TPYS<sup>(1)</sup>

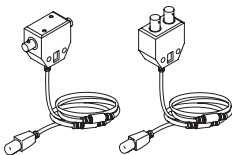

1786-TP (temporary  
network connections)

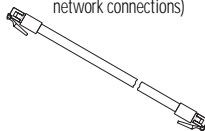

Small Screwdriver (optional)

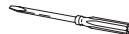

<sup>(1)</sup> 1786-TPS or 1786-TPYS taps recommended for network connections.

- Know the type of ControlNet network:

There are two types of scheduled traffic networks for ControlNet: single-keeper networks and multi-keeper networks.



All 1756-CNB and 1756-CNBR modules are keeper-capable, as listed.

<b>1756-CNB and 1756-CNBR</b>	<b>Major/Minor Revision</b>	<b>Keeper Type</b>
A	1.xx	Single-keeper
B	2.xx	Multi-keeper
C	3.xx	Single-keeper
C	4.xx	Multi-keeper
D	5.xx	Multi-keeper
D	7.xx	Multi-keeper
E	10.xx	Multi-keeper
E	11.xx	Multi-keeper

You must match the keeper to the type of network, or upgrade the firmware of the module at MAC ID 01 to be multi-keeper capable. Refer to the ControlNet Modules in Logix5000 Control Systems User Manual, publication CNET-UM001, for more information.

## Identify Module Features

Refer to the figure Module Features to identify the hardware components of the 1756-CNB and 1756-CNBR modules.

### Module Features

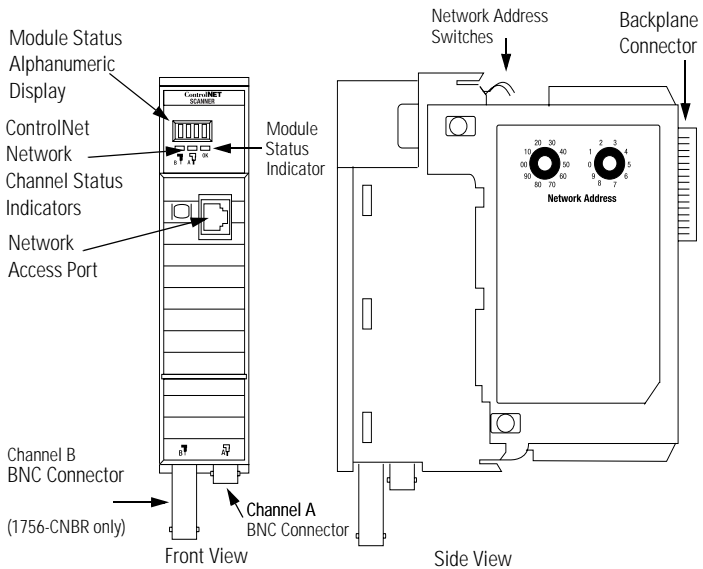

## Set the Module's Network Address Switches

Use your fingers or a small screwdriver to set the module's network address switches. For modules in a standalone chassis, you must specify a unique ControlNet network address; for modules in a redundant chassis, you must specify the same address for the secondary module that you specified for the corresponding primary module.

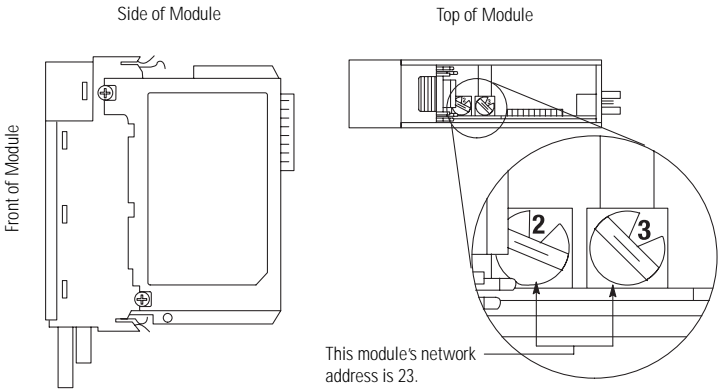
**TIP**

You can select an address of 01 to 99 for modules in a standalone chassis or 01 to 98 for modules in redundant chassis. 00 is an invalid ControlNet network address.

## Prepare the Chassis for Module Installation

Before you install the module, you must install and connect a ControlLogix chassis and power supply. A 4-slot chassis with a power supply is shown in the figure Chassis and Power Supply.

### Chassis and Power Supply

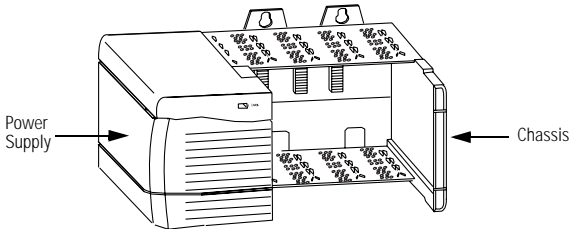

For information on installing these products, refer to the table Chassis Installation Publications.

### Chassis Installation Publications

Chassis Type	Chassis Installation	Power Supply	Power Supply Installation
Series B 1756-A4 1756-A7	Publication 1756-IN080	1756-PA72/B	Publication 1756-5.67
		1756-PB72/B	
1756-A10 1756-A13		1756-PA75/A	Publication 1756-5.78
		1756-PB75/A	

---

## Determine Module Slot Location

The figure Chassis Slot Numbering shows chassis slot numbering in a 4-slot chassis. Slot 0 is the first slot and is always the leftmost slot in the rack (the first slot to the right of the power supply). You can use any size ControlLogix chassis and install the module in any slot. You can also install multiple 1756-CNB and 1756-CNBR modules in the same chassis. You can install as many modules as your power supply can accommodate (such as the number for which the power supply is rated).

**IMPORTANT**

If you plan to install a redundant system, you must place the primary and redundant modules in the same corresponding slot in their respective chassis. For example, if you place a 1756-CNBR module in slot 3 (from the left) in the primary chassis, you must also place a 1756-CNBR module in slot 3 in the redundant chassis.

---

## Chassis Slot Numbering

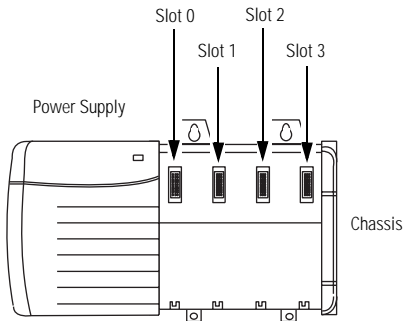

## Install or Remove the Module Under Power

You can install or remove the module while chassis power is applied if you observe the following precautions.

---

**WARNING**



When you insert or remove the module while backplane power is on, an electrical arc can occur. This could cause an explosion in hazardous location installations.

Be sure that power is removed or the area is nonhazardous before proceeding. Repeated electrical arcing causes excessive wear to contacts on both the module and its mating connector. Worn contacts may create electrical resistance that can affect module operation.

---

## Install the Module

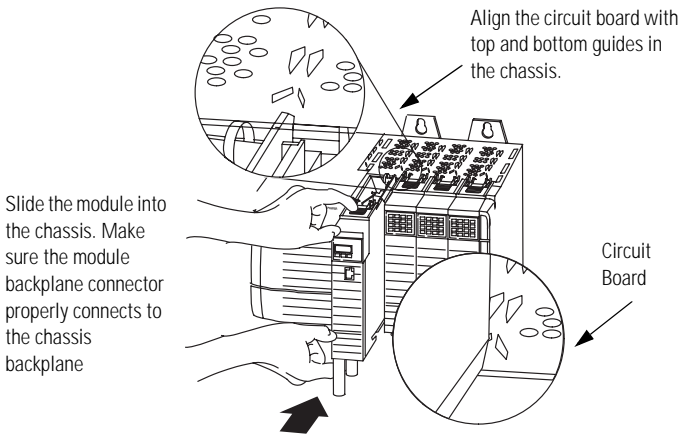

The module is properly installed when it is flush with the power supply or other installed modules.

**ATTENTION**

Do not force the module into the backplane connector. If you cannot seat the module with firm pressure, check the alignment. Forcing the module into the chassis can damage the backplane connector or the module.

## Remove the Module

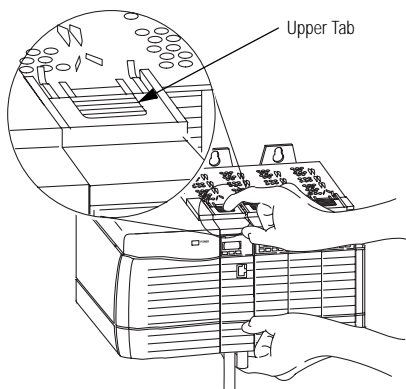

Push on the upper and lower tabs to disengage them. Then slide the module out of the chassis.

If you are replacing an existing module with an identical one, and you want to resume identical system operation, you must install the new module with the same ControlNet address in the same slot.



## Connect the Module to the Network

You can connect the module to the ControlNet network using a tap (1786-TPR, 1786-TPS, 1786-TPYR, or 1786-TPYS) or a network access cable (1786-CP).

### WARNING



If you connect or disconnect the communications cable with power applied to this module or any device on the network, an electrical arc can occur. This could cause an explosion in hazardous location installations.

### TIP

Use the 1786-CP cable for temporary connections, such as programming software. For permanent connections, use a tap.

The following figure shows an example ControlNet network using redundant media.

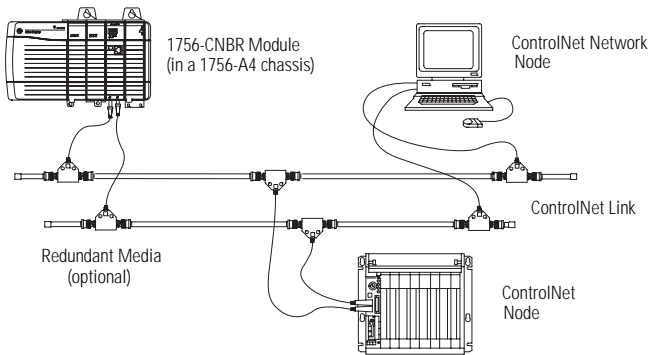

When connecting the module to a ControlNet network, you should also refer to the following documentation:

- ControlNet Coax Tap Installation Instructions, publication 1786-5.7
- ControlNet Cable System Planning and Installation Manual, publication CNET-IN002

**TIP**

For network connections we recommend taps with a straight connector (1786-TPS or 1786-TPYS) because of the location of the BNC connectors on the bottom of the module.

## Connect to the Network with a Tap

Perform the following steps to connect the module to the network using a tap.

1. Remove and save the dust caps from the ControlNet network taps.

### ATTENTION



Do not allow any metal portions of the tap to contact any conductive material. If you disconnect the tap from the module, place the dust cap back on the straight or right-angle connector to prevent the connector from accidentally contacting a metallic grounded surface.

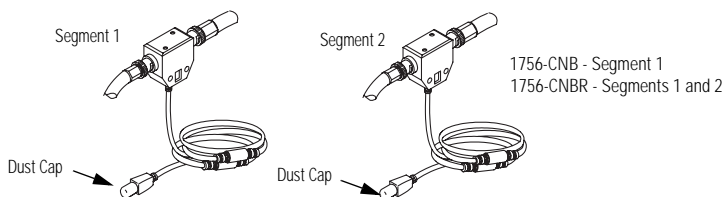

2. Connect the tap's straight or right-angle connector to the module's BNC connector.

If Your Node Supports	Connect The Tap's Connector
nonredundant media 1756-CNB	to the channel A connector on the module (channel B on the 1756-CNBR is not used) <sup>(1)</sup>
redundant media	<ul style="list-style-type: none"> <li>• from trunkline A to channel A on the 1756-CNBR</li> <li>• from trunkline B to channel B on the 1756-CNBR</li> </ul>

<sup>(1)</sup> While both channels are active, Rockwell recommends using channel A for nonredundant media.

**IMPORTANT**

To prevent inadvertent reversal of the tap connections (resulting in incorrect status displays requiring troubleshooting), check the tap drop cable for the label indicating the attached segment before making your connection.

To work properly, when you use modules in a redundant control chassis pair, the primary and redundant partner modules must be connected to the same network segment. If you are using redundant media, connect the channel of each partner to the same network segment.

---

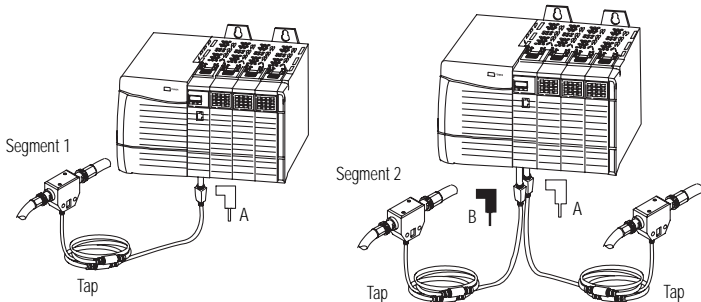

### 3. Apply power to the module and check module status.

Use the following flowchart as a guide.

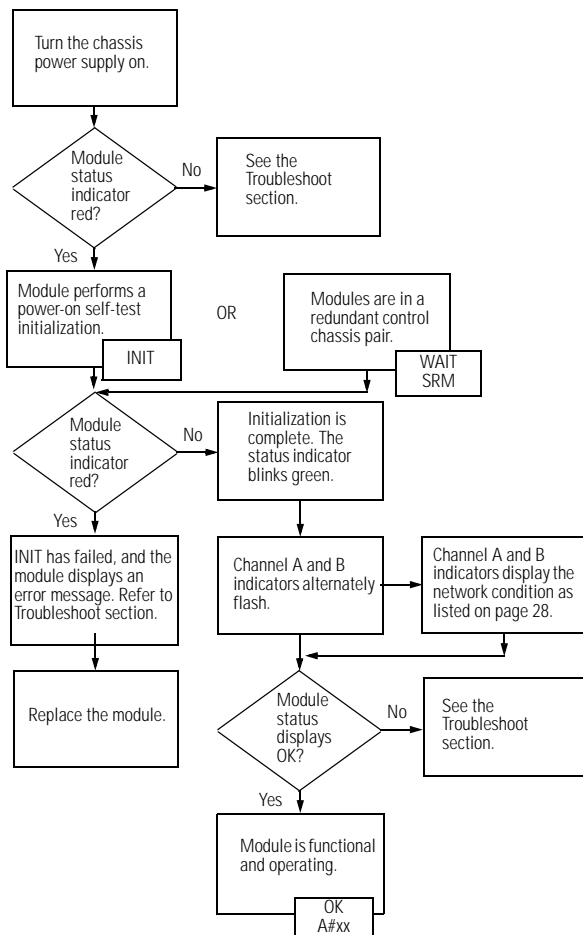

## Connect a Programming Terminal to the Network with a 1786-CP Cable

To connect a programming terminal to the network using a 1786-CP cable, you have the following options:

- Use a 1784-KTC, 1784-KTCx, or 1784-PCC communication card and a 1786-CP cable:

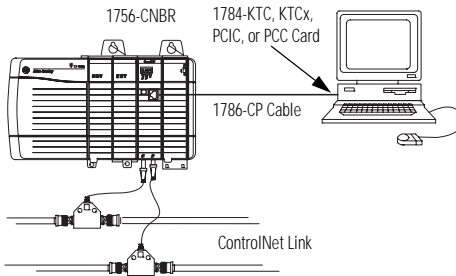

### IMPORTANT

To work properly, the primary and redundant partner module must be connected to the same network segment. If you are using redundant media, connect the channel of each partner to the same network segment.

- Use a 1770-KFC communication interface, a serial or parallel connection, and a 1786-CP cable:

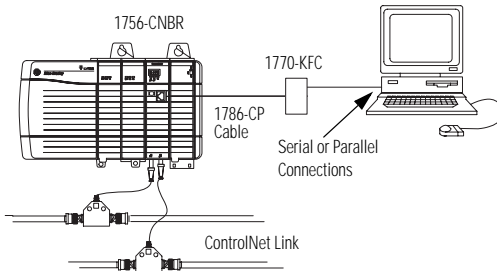

The 1786-CP cable can be plugged into any ControlNet network product's network access port (NAP) to provide programming capability on the ControlNet network. A programming terminal connected through this cable is counted as a node and must have a unique network address.

**ATTENTION**

Use a 1786-CP cable when connecting a programming terminal to the network through network access port (NAP). Using a commercially available RJ-style cable could result in network failure.

## Troubleshoot the Module

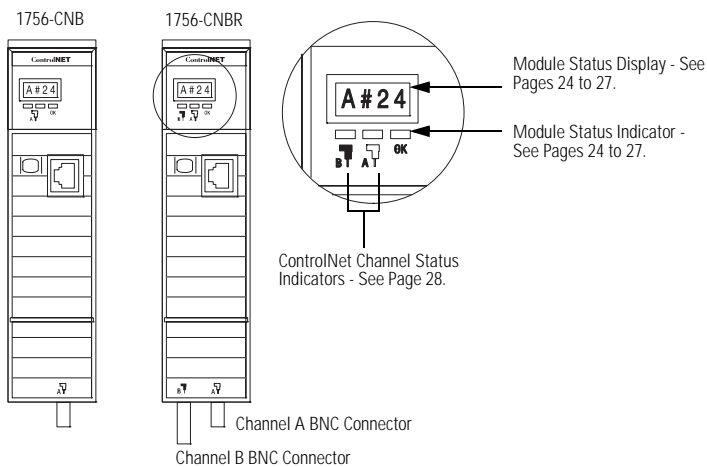

The 1756-CNB and 1756-CNBR modules have the diagnostic indicators as shown:



## Interpret the Module Status Indicator and Display



The Module Status Indicator LED and Module Status Display table provide diagnostic information.

### Module Status Indicator LED and Module Status Display



LED	Display		
 OK		Cause	Action
Off	None	The module is not communicating due to a power supply fault or internal fault.	<ol style="list-style-type: none"> <li>1. Check the power supply.</li> <li>2. Check the cable connectors.</li> <li>3. Make sure the module is firmly seated in the chassis.</li> <li>4. If the indicator remains off, replace the module.</li> </ol>
Red	Msg scrolls <sup>(1)</sup>	The module's network address is set to 00, an invalid ControlNet network address, or 99, an invalid ControlNet network address if you are using redundant control. See footnote at end of table.	<ol style="list-style-type: none"> <li>1. (Optional, see page 12.) Turn chassis power supply off.</li> <li>2. Remove the module from the chassis.</li> <li>3. Set the network address switches to a unique address (01-99, or 01-98 if redundant control)</li> <li>4. Install the module in the chassis.</li> <li>5. If off, turn chassis power supply on.</li> </ol>
	BPA# ERR	The module detected a different slot address from that latched in at power-up. Excessive noise on the backplane causes this error.	Replace the chassis or module.
	BPRX ERR	There are too many CRC errors being generated by the multicast backplane receiver, so the backplane multicast receivers have been shut off.	Replace the module.
	BPIC ERR	There is a hardware fault within the module.	Replace the module.
	CNIC ERR		





## Module Status Indicator LED and Module Status Display

LED	Display		
			
	OK		
		Cause	Action
Red	DUPL NODE	For a redundant system this may be a temporary condition during chassis switchover. Otherwise, the module's network address is the same as another module's on the link.	<ol style="list-style-type: none"> <li>(For redundant systems only.) Wait 10 seconds; if the condition persists, perform the following steps:</li> <li>(Optional, see page 12.) Turn chassis power supply off.</li> <li>Remove the module from the chassis.</li> <li>Set the network address switches to a unique address (01-99).</li> <li>Install the module in the chassis.</li> <li>If off, turn chassis power supply on.</li> </ol>
	RACK ERR	Cannot read backplane EEPROM, or rack/slot address incorrect	Replace the chassis.
	STOP	The module commanded to stop functioning by the redundancy module. This occurs when a nonredundancy compliant module is placed into a redundant secondary chassis.	Remove nonredundancy compliant module from redundant secondary chassis and replace with redundancy compliant module.
	WAIT SRM <sup>(2)</sup>	The module waiting for the redundancy module to complete power-up.	None required.
	Flashing Red	BOOT	The module has invalid firmware.
ROM		Flash update is in progress.	None required.
UPDT			
	SNGL KPR!	The module detected that it has been connected to a ControlNet 1.5 (single-keeper) network.	Update the module's firmware at MAC ID 01 and reschedule the network.

**Module Status Indicator LED and Module Status Display**

LED	Display		
 OK		Cause	Action
Green	OK	Normal operation	None required
	INIT	The module is initializing.	
	BW >MAX	The module is receiving too much network traffic and connections are timing out. The network bandwidth has been exceeded.	None (temporary condition).  If this happens frequently, add another 1756-CNB or 1756-CNBR and split the traffic between them.
	CMPT <sup>(2)</sup>	The secondary module is compatible with its partner.	None required.
	DSNP <sup>(2)</sup>	The secondary module is disqualified with no partner.	Check corresponding slot of primary chassis for type and revision of module.
	PwDS <sup>(2)</sup>	The module is primary with a disqualified secondary partner.	Check the type and revision of the 1756-CNB module.
	PwQg <sup>(2)</sup>	The module is primary with a qualifying secondary partner.	Redundant system status. No action required.
	PwQS <sup>(2)</sup>	The module is primary with a qualified secondary partner.	
	PwNS <sup>(2)</sup>	The module is primary with no secondary partner.	Check corresponding slot of secondary chassis for correct module.
	Qfng <sup>(2)</sup>	The secondary module is qualifying.	Redundant system status. No action required.
	QS <sup>(2)</sup>	The secondary module is qualified.	
	SW ERR	The node address switch changed after power-up.	None required, but we recommend that you either return switches to their original settings or replace the module, since this could indicate a latent hardware problem.

## Module Status Indicator LED and Module Status Display

LED	Display		
		Cause	Action
 OK			
Flashing Green	CNFG ERR	ControlNet network configuration error.	Recheck configuration.
	NET ERR	Network cabling error or no other active nodes on network.	Re-check your network cabling and make sure another node on the network is active (online).
Green or Off	SO_1 <sup>(2)</sup>	Old primary switchover phase 1 in progress.	If the display shows any message for more than three seconds, then the module failed during transition from one redundancy phase to another. Replace one or both redundancy modules.
	SO_2 <sup>(2)</sup>	Old primary switchover phase 2 in progress.	
	SO_3 <sup>(2)</sup>	Old primary switchover phase 3 in progress.	
	SN_1 <sup>(2)</sup>	New primary switchover phase 1 in progress.	
	SN_2 <sup>(2)</sup>	New primary switchover phase 2 in progress.	
	SN_3 <sup>(2)</sup>	New primary switchover phase 3 in progress.	
	?Cpt <sup>(2)</sup>	the module has not determined if it is compatible.	
!Cpt <sup>(2)</sup>	the module has determined that it is not compatible.	Replace the module with correct type and revision.	

<sup>(1)</sup> If switches are set to 00 the display scrolls: "FAULT: ADDRESS SWITCHES = 00, ILLEGAL"

If switches are set to 99 in a redundant chassis, the display scrolls: "FAULT: ADDRESS SWITCHES = 99, ILLEGAL IN REDUNDANT SYSTEM"

<sup>(2)</sup> Messages are for redundant control. These messages will be available in Series E firmware version 11.xx.



## ControlNet Network Channel Status Indicators

The ControlNet network channel status indicators appear in one of the following states:



- Steady - indicator is on continuously in the defined state.
- Alternating - the two indicators alternate between the two defined states at the same time (applies to both indicators viewed together). The two indicators are always in opposite states, out of phase.
- Flashing - the indicator alternates between the two defined states (applies to each indicator viewed independent of the other). If both indicators are flashing, they must flash together, in phase.

The ControlNet Network Channel Status Indicators table summarizes the meanings of these states.



### ControlNet Network Channel Status Indicators

 and 	Cause	Action
Off	No power	None or power up.
Steady red	Faulted unit	Cycle power or reset unit.  If fault persists, contact A-B representative or distributor.
Alternating red/green	Self-test	None
Alternating red/off	Incorrect node configuration	Check network address and other ControlNet network configuration parameters.

 or 	Cause	Action
Off	Channel disabled	Program network for redundant media, if required.
Steady green	Normal operation	None
Flashing green/off	Temporary errors	None; unit will self-correct.

### ControlNet Network Channel Status Indicators

 A	and	 B	Cause	Action
			Node is not configured to go on line	Make sure the configuration manager node is present and working and selected address is not greater than selected UMAX. <sup>(1)</sup>
Flashing red/off			Media fault	Check media. For example: broken cables, loose connectors, missing terminators.
			No other nodes present on network	Add other nodes to the network.
Flashing red/green			Incorrect network configuration	Cycle power or reset unit.
				If fault persists, contact A-B representative or distributor.

<sup>(1)</sup> The configuration manager node is the node responsible for distributing ControlNet network configuration data to all nodes on the network.

## Specifications

### ControlLogix ControlNet Interface Module 1756-CNB, 1756-CNBR, Series E

Attribute	Value
Connectors	
1756-CNB	1 BNC connector for nonredundant media operation 1 NAP (RJ-45 8-pin with shield)
1756-CNBR	2 BNC connectors for redundant media operation 1 NAP (RJ-45 8-pin with shield)
Cable	Quad shield RG-6 coaxial cable
Ground isolation	Transformer
ControlNet network communication rate	5 M
Diagnostics	Yes
Weight	
1756-CNB	0.260 kg (0.57 lb)
1756-CNBR	0.293 kg (0.64 lb)
Mounting type	Chassis
Mounting location	1756 ControlLogix Chassis
Number of nodes, max	99
Slot width	1
Connections supported, max	64
Communication interface type	Bridge
Device type	Communication interface
Power dissipation	5.14 W
Thermal dissipation	17.5 BTU/hr

**ControlLogix ControlNet Interface Module 1756-CNB, 1756-CNBR, Series E**

Attribute	Value
Backplane current	970 mA @ 5.1 V 1.7 mA @ 24 V
Isolation voltage (continuous-voltage withstand rating)	50V Tested to 500V ac for 60 seconds
Wiring category <sup>(1)</sup>	2 - on communications ports

<sup>(1)</sup> Use this Conductor Category information for planning conductor routing. Refer to Industrial Automation Wiring and Grounding Guidelines, publication 1770-4.1.

**Environmental Specifications ControlLogix ControlNet Interface Module 1756-CNB, 1756-CNBR, Series E**

Attribute	Value
Operational temperature	IEC 60068-2-1 (Test Ad, Operating Cold), IEC 60068-2-2 (Test Bd, Operating Dry Heat), IEC 60068-2-14 (Test Nb, Operating Thermal Shock): 0...60 °C (32...140 °F)
Storage temperature	IEC 60068-2-1 (Test Ab, Unpackaged Nonoperating Cold), IEC 60068-2-2 (Test Bb, Unpackaged Nonoperating Dry Heat), IEC 60068-2-14 (Test Na, Unpackaged Nonoperating Thermal Shock): -40...85 °C (-40...185 °F)
Relative humidity	IEC 60068-2-30 (Test Db, Unpackaged Nonoperating Damp Heat): 5...95% noncondensing
Vibration	IEC 60068-2-6 (Test Fc, Operating): 2 g @ 10...500 Hz
Operating shock	IEC 60068-2-27 (Test Ea, Unpackaged Shock): 30 g
Nonoperating shock	IEC 60068-2-27 (Test Ea, Unpackaged Shock): 50 g
Emissions	CISPR 11: Group 1, Class A

**Environmental Specifications ControlLogix ControlNet Interface Module  
1756-CNB, 1756-CNBR, Series E**

Attribute	Value
ESD immunity	IEC 61000-4-2: 6 kV contact discharges 8 kV air discharges
Radiated RF immunity Series E	IEC 61000-4-3: 10 V/m with 1 kHz sine-wave 80%AM from 30...2000 MHz 10 V/m with 200 Hz 50% Pulse 100%AM at 900 MHz 10 V/m with 200 Hz 50% Pulse 100%AM at 1890 MHz 1 V/m with 1 kHz sine-wave 80%AM from 2000 MHz...2700 MHz
EFT/B immunity	IEC 61000-4-4: ±2 kV at 5 kHz on communications ports
Surge transient immunity	IEC 61000-4-5: ±2 kV line-earth(CM) on communications ports
Conducted RF immunity	IEC 61000-4-6: 10V rms with 1 kHz sine-wave 80%AM from 150 kHz...80 MHz
Enclosure type rating	None (open-style)



## Certifications 1756-CNB Series E and 1756-CNBR, Series E

Certification	Value
Certifications (when product is marked) <sup>(1)</sup>	<ul style="list-style-type: none"> <li data-bbox="381 273 926 303">UL UL Listed Industrial Control Equipment</li> <li data-bbox="381 341 926 402">cULus UL Listed for Class I, Division 2 Group A,B,C,D Hazardous Locations, certified for U.S. and Canada</li> <li data-bbox="381 432 926 462">CSA CSA Certified Process Control Equipment</li> <li data-bbox="381 492 926 553">CSA CSA Certified Process Control Equipment for Class I, Division 2 Group A,B,C,D Hazardous Locations</li> <li data-bbox="381 583 926 644">FM FM Approved Equipment for use in Class I Division 2 Group A,B,C,D Hazardous Locations</li> <li data-bbox="381 674 926 938">CE European Union 89/336/EEC EMC Directive, compliant with: EN 50082-2; Industrial Immunity EN 61326; Meas./Control/Lab., Industrial Requirements EN 61000-6-2; Industrial Immunity EN 61000-6-4; Industrial Emissions EN 61131-2; Programmable Controllers (Clause 8, Zone A &amp; B)</li> <li data-bbox="381 969 926 1029">C-Tick Australian Radiocommunications Act, compliant with: AS/NZS CISPR 11; Industrial Emissions</li> <li data-bbox="381 1059 926 1180">EEx European Union 94/9/EC ATEX Directive, compliant with: EN 50021; Potentially Explosive Atmospheres, Protection "n" (Zone 2)</li> <li data-bbox="381 1211 926 1271">CI ControlNet Int'l conformance tested to ControlNet network specifications</li> </ul>

<sup>(1)</sup> See the Product Certification link at [www.ab.com](http://www.ab.com) for Declarations of Conformity, Certificates, and other certification details.

## Additional Resources

<b>Publication Title</b>	<b>Publication Number</b>
Industrial Automation Wiring and Grounding Guidelines	1770-4.1
ControlNet Modules in Logix5000 Control Systems	CNET-UM001
ControlLogix Chassis Installation Instructions	1756-IN080
ControlLogix Power Supplies Installation Instructions	1756-IN078
ControlLogix Power Supplies Installation Instructions	1756-IN596
ControlNet Coax Tap Installation Instructions	1786-5.7
ControlNet Coax Media Planning and Installation Guide	CNET-IN002
ControlNet Fiber Media Planning and Installation Guide	CNET-IN001

ControlLogix is a trademark of Rockwell Automation, Inc.

Trademarks not belonging to Rockwell Automation are property of their respective companies.

## Notes:

## Rockwell Automation Support

Rockwell Automation provides technical information on the web to assist you in using its products. At <http://support.rockwellautomation.com>, you can find technical manuals, a knowledge base of FAQs, technical and application notes, sample code and links to software service packs, and a MySupport feature that you can customize to make the best use of these tools.

For an additional level of technical phone support for installation, configuration and troubleshooting, we offer TechConnect Support programs. For more information, contact your local distributor or Rockwell Automation representative, or visit <http://support.rockwellautomation.com>.

## Installation Assistance

If you experience a problem with a hardware module within the first 24 hours of installation, please review the information that's contained in this manual. You can also contact a special Customer Support number for initial help in getting your module up and running:

United States	1.440.646.3223 Monday – Friday, 8am – 5pm EST
Outside United States	Please contact your local Rockwell Automation representative for any technical support issues.

## New Product Satisfaction Return

Rockwell tests all of its products to ensure that they are fully operational when shipped from the manufacturing facility. However, if your product is not functioning and needs to be returned:

United States	Contact your distributor. You must provide a Customer Support case number (see phone number above to obtain one) to your distributor in order to complete the return process.
Outside United States	Please contact your local Rockwell Automation representative for return procedure.

[www.rockwellautomation.com](http://www.rockwellautomation.com)

### Corporate Headquarters

Rockwell Automation, 777 East Wisconsin Avenue, Suite 1400, Milwaukee, WI, 53202-5302 USA, Tel: (1) 414.212.5200, Fax: (1) 414.212.5201

### Headquarters for Allen-Bradley Products, Rockwell Software Products and Global Manufacturing Solutions

Americas: Rockwell Automation, 1201 South Second Street, Milwaukee, WI 53204-2496 USA, Tel: (1) 414.382.2000, Fax: (1) 414.382.4444  
Europe/Middle East/Africa: Rockwell Automation SA/NV, Vorstlaan/Boulevard du Souverain 36, 1170 Brussels, Belgium, Tel: (32) 2 663 0600, Fax: (32) 2 663 0600  
Asia Pacific: Rockwell Automation, Level 14, Core F, Cyberport 3, 100 Cyberport Road, Hong Kong, Tel: (852) 2887 4788, Fax: (852) 2508 1846

### Headquarters for Dodge and Reliance Electric Products

Americas: Rockwell Automation, 6040 Ponders Court, Greenville, SC 29615-4617 USA, Tel: (1) 864.297.4800, Fax: (1) 864.281.2433  
Europe/Middle East/Africa: Rockwell Automation, Herman-Heinrich-Gossen-Strasse 3, 50858 Köln, Germany, Tel: 49 (0) 2234 379410, Fax: 49 (0) 2234 3794164  
Asia Pacific: Rockwell Automation, 55 Newton Road, #11-01/02 Revenue House, Singapore 307987, Tel: (65) 6356 9077, Fax: (65) 6356 9011